



Architectural Ironmongery Ltd

# MAILBOX SOLUTIONS

contents

10 year guarantee



weather proof



British standard



front entry rear retrieval

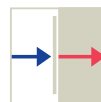

front entry front retrieval



fire rated



**Freestanding & Wall Applications**

This section covers all front delivery front retrieval mailboxes that can be wall mounted, recessed or freestanding if space is restricted or there is a limited wall cavity depth. These can be installed internally or externally.



PAGE 02

**Front Delivery / Rear Retrieval**

For all through the wall or glazed panel applications, please have a look through these solutions. Our sloping models are preferred options against fishing opportunists too.



PAGE 06

**Transcript by Jean Nouvel**

The TRANSCRIPT system is designed to adapt to every architectural configuration, imagined by Jean Nouvel, it constitutes a world premiere. Transcript mailboxes assemble themselves like bricks and blend into a thin aluminium wall, sturdy and grooved, which doubles the existing wall as a second skin.



PAGE 10

**Casings & Trims**

Our high quality casings and trims can be incorporated into all the freestanding and wall applications.

PAGE 12

**Stands**

Our high quality stands can be incorporated into all the freestanding and wall applications.

PAGE 13

**Colours, Finishes & Engraving**

We have an extensive list of RAL colours, finishes and engraving options to suit all requirements.

PAGE 14

**Our Services**

Please read this section to discover more about our additional services.

PAGE 16



# freestanding & wall applications



## Freestanding & Wall Applications

In situations where there is not enough wall space, the wall cavity is not very deep or the mailboxes are simply required to stand alone, the DAD freestanding range provides a number of well-designed solutions to meet these requirements. These can be installed internally or externally. The wide choice of surrounds and frames allow the units to be integrated with either the interior or exterior decor of the building.

Our freestanding, wall mounted and recessed mailboxes comply to BS/EN 13724 as well as the New Homes Guide 2010. The mailboxes and other components can either be made of electro-galvanised steel with door and flaps in aluminium or in stainless steel and take standard A4 size mail. Each flap has gasket seals to guarantee water-tightness. An internal anti-theft device is fitted as standard behind the flap and the boxes in this range have good waterproof features. All boxes have a door with a security lock complete with 2 numbered keys.



**Model 2030-1 RAL1015**  
**St Georges Wharf | Battersea | London**



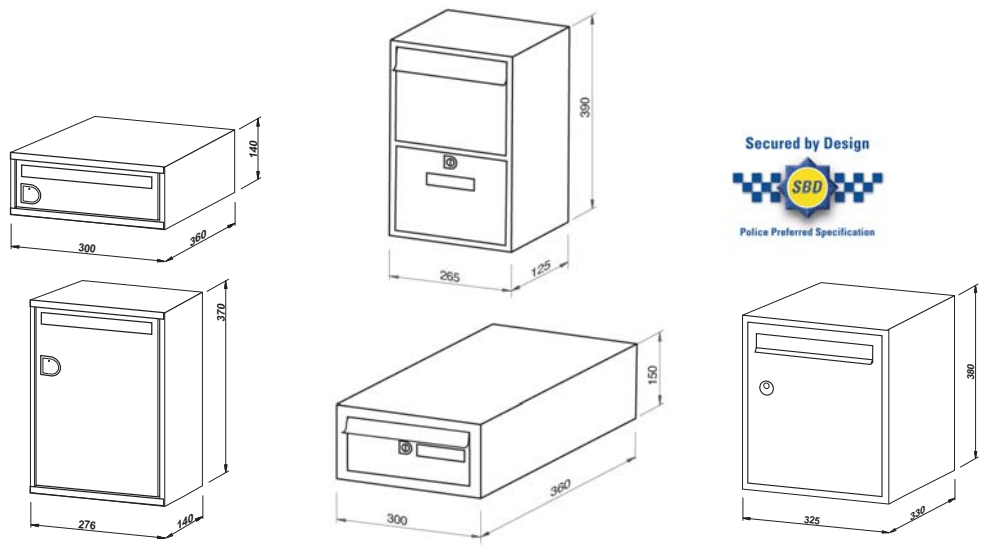

Model	FR60 (1hr Fire rated)	HEAVY DUTY	DAD009
Dimensions (W x H x D)	<b>FR60MBH</b> 300 x 140 x 360mm <b>FR60MBV</b> 276 x 370 x 140mm	<b>HD1</b> 265 x 392 x 125mm <b>HD2</b> 300 x 150 x 360mm	325 x 380 x 330mm
Aperture	235 x 25mm	HD1 232 x 25mm HD2 265 x 25mm	230 x 40mm
additional options			
Master Key	●	●	●
Engraving	●	●	●
Intercom system	n/a	n/a	n/a
finishes			
Any RAL powder coated enamel	●	●	●
Stainless steel* Rust proof (15 year guarantee)	n/a	n/a	n/a

\*Door and flap only

[View our surrounds and stands](#)

## Locking Options



SALTO



TOTAL OPENING



SMARTPHONE



KEY FOBs



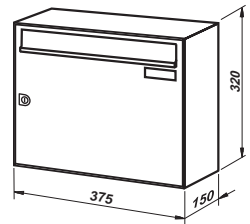
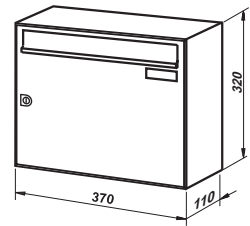
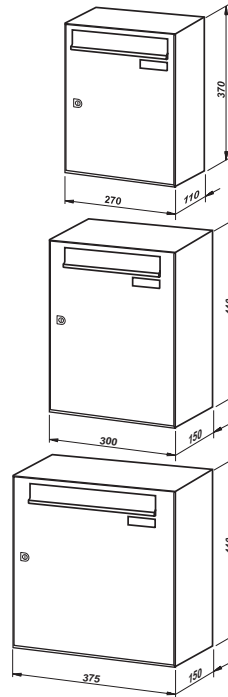
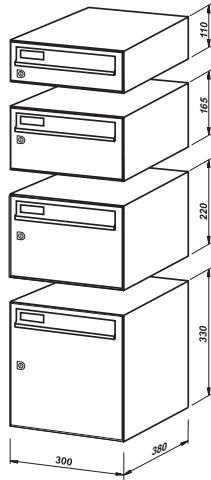
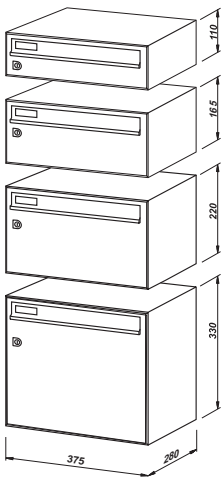

**2010**

**2010-1** 375 x 110 x 280mm

**2010-16** 375 x 165 x 280mm

**2010-2** 375 x 220 x 280mm

**2010-3** 375 x 330 x 280mm

325 x 35mm

**2030**

**2030-1** 300 x 110 x 380mm

**2030-16** 300 x 165 x 380mm

**2030-2** 300 x 220 x 380mm

**2030-3** 300 x 330 x 380mm

260 x 30mm

**2040**

**2040** 270 x 370 x 110mm

**2040XL** 300 x 440 x 150mm

**2040XXL** 375 x 440 x 150mm

235-325 x 35mm

**2070**

**2070-1** 375 x 320 x 110mm

**2070-2** 375 x 320 x 150mm

325 x 35mm

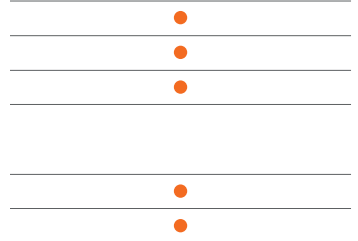
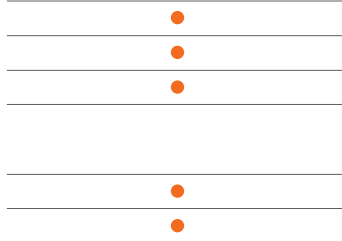
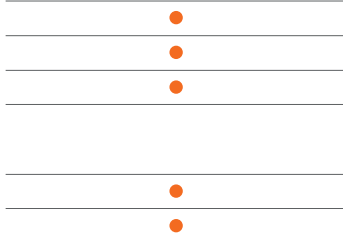
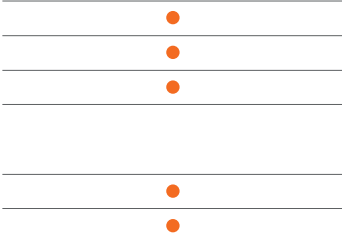

**Designs - Consult our design team for suggestions**



# front delivery rear retrieval



## Front delivery Rear retrieval

This mailbox system is the most appealing for front delivery and rear retrieval.

The system can be fitted through a cavity wall, by an entrance door through a single/double glazing panel or in any frame. Its one-piece design makes the unit neat and offers the latest improvements against vandalism. Made to measure, the front plate is made of 3mm thick aluminium or stainless steel and can be adapted to any configuration. The curved flap design enhances the appearance. Each flap has gasket seals to ensure water-tightness.

The mailboxes can be adapted in finishes and sizes to suit any exterior or interior location and all come with a lockable inner door (cylinder with 2 keys). An internal anti-theft device is also fitted as standard behind the flap.



**Model 2700-1, one-piece front plate RAL7047  
Greenwich Millennium Village (GMV), Greenwich, London**





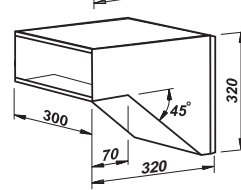
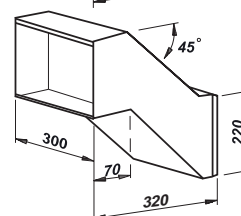
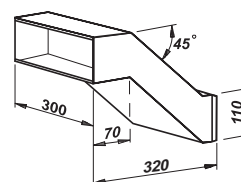
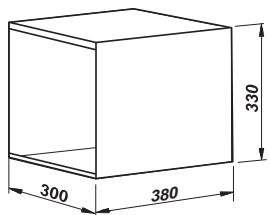
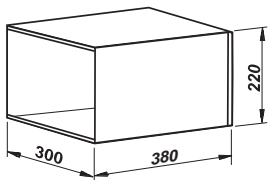
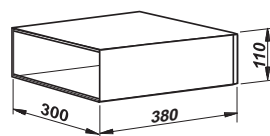

Model	2035	2700
Dimensions (W x H x D)	<b>2035-1</b> 300 x 110 x 380mm <b>2035-2</b> 300 x 220 x 380mm <b>2035-3</b> 300 x 330 x 380mm	<b>2700-1</b> 300 x 110 x 320mm <b>2700-2</b> 300 x 220 x 320mm <b>2700-3</b> 300 x 320 x 320mm
Aperture	280 x 35mm	280 x 35mm
additional options		
Master Key	●	●
Engraving	●	●
Intercom system	●	●
Glazed panel	●	●
Through wall	●	●
finishes		
Any RAL powder coated enamel	●	●
Stainless steel* Rust proof (15 year guarantee)	●	●

\*Front plate only



**We can integrate with any door manufacturer to provide a complete and secure solution when it comes to mail delivery to apartment buildings.**

**Contact us for more details**

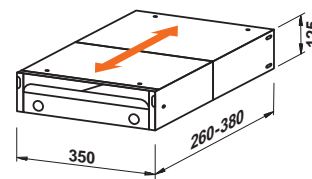
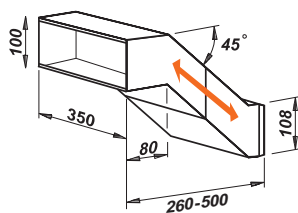
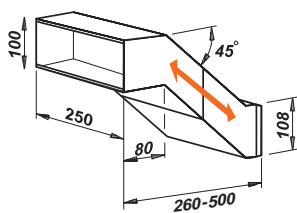

**2000/2000+**

250 x 100 x 260-500mm

230 x 35mm

- 
- 
- 
- 
- 

- 
- 

**2002/2002+**

350 x 125 x 260-500mm

330 x 35mm

- 
- 
- 
- 
- 

- 
- 

**2375**

350 x 125 x 260-380mm

330 x 35mm

- 
- 
- 
- 
- 

- 
- 



**Ask about our  
Steel Sliding Doors**

# TRANSCRIPT

## by Jean Nouvel



*“The entrance way of a building is a space that tells about its inhabitants, its families or its companies: it’s a noble place that also must be the pride and joy of those who walk across it, and command everybody’s respect. The point here was to think of a global system the mailboxes would be a part of, that would simply ensure, whatever the typology of the entrance ways it’s built in, the quality of the space.”*

The Transcript system comes as a wall. It creates architecture and identity. Beyond its apparent simplicity, a set of components that you put like a lining for an architecture and that adapts to any place, a 16th century building just as well as a contemporary building. The device can completely cover the space, but not necessarily...It includes mailboxes, parcel boxes, billboards, signposting, and all the functions of an entrance way. Being modular, this system allows changing the number or the layout of mailboxes according to changes occurring in the building.

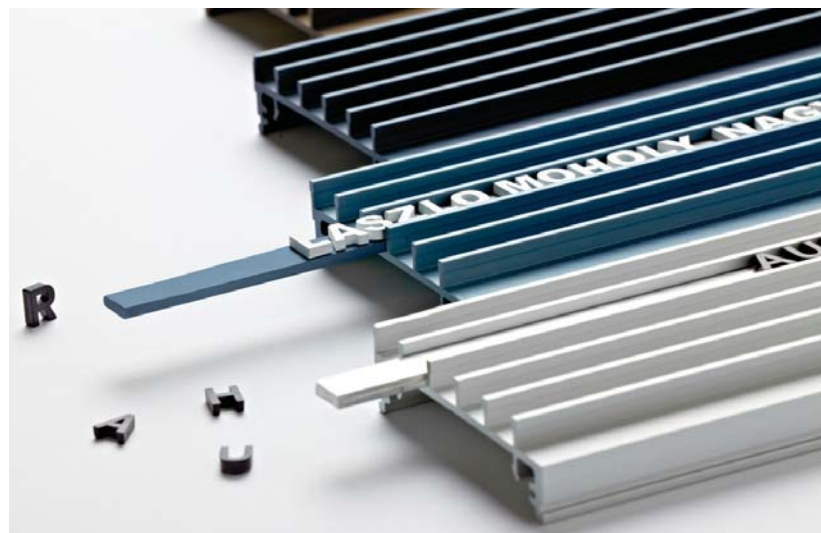

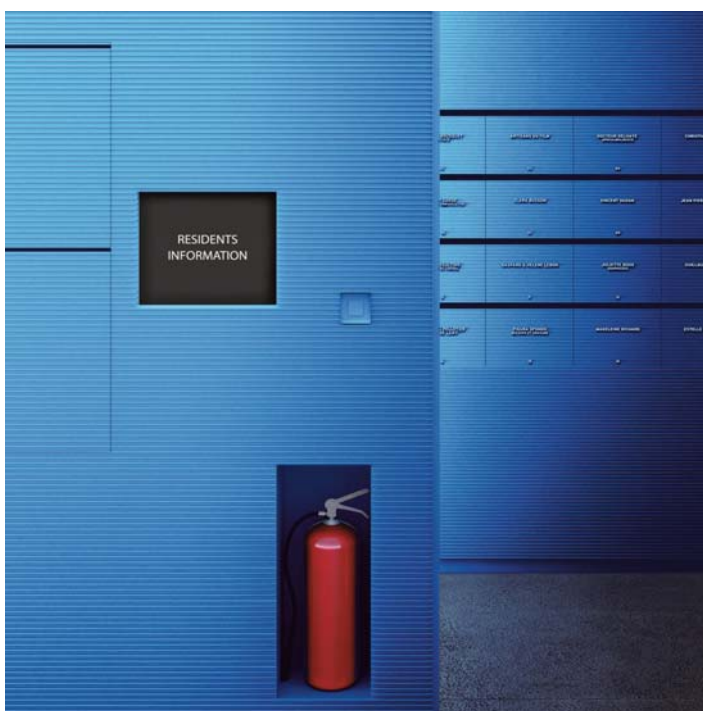

# casings and trims

The following different surrounds and stands, are suitable for use with the Wall Application or the Freestanding ranges and are indicated accordingly below. Apart from their practical uses, they also provide a neat finish to the mailbox systems, whether used for one or more boxes, ensuring they are housed and supported suitably. The surrounds and stands are all available in matching finishes and colours to suit the base unit and with different angles and features they provide an enhanced look.

## Surrounds and stands

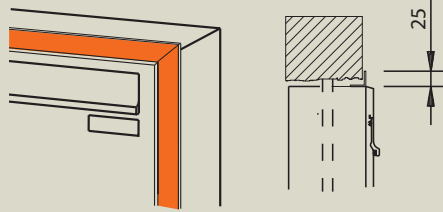

### PE Surround

Surround for wall applications only  
Right-angled shaped aluminium profile

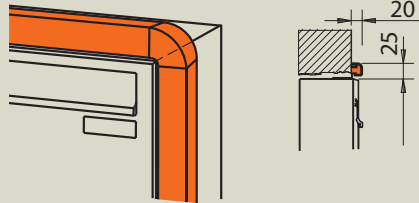

### PR Surround

Surround for in wall application only  
Rounded profile frame, coated in zinc

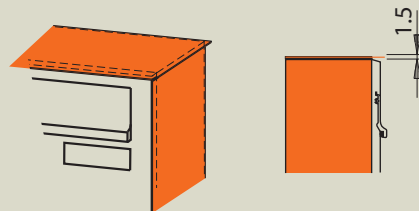

### EP Surround

Surround for against the wall applications  
or freestanding mailboxes only.  
Right-angled surround, in aluminium

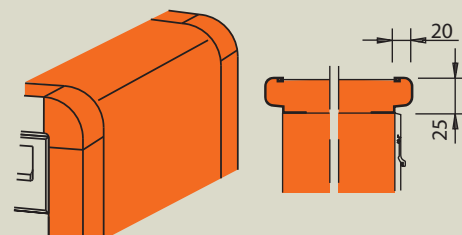

### PRD Surround

Decorative rounded surround for against  
the wall applications or freestanding  
mailboxes only.

# stands



**All frames and stands on pages 12 and 13 are available in any of the standard finishes or special powder coated enamel colours. Anodised finishes, or stainless steel, are also available depending on the chosen finish of the box.**

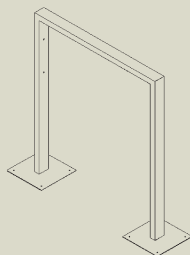

#### **RTG Frame**

Rectangular aluminium frame for bolt fixing or fixing into concrete. Base plate for bolt fixing available as an extra. The frame is for freestanding applications only.

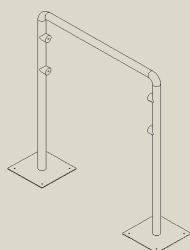

#### **RRR Frame**

Steel tubular frame for bolt fixing or fixing into concrete. Base plate for bolt fixing is available as an extra. The frame is for freestanding applications only.

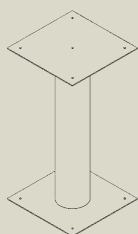

#### **RF Stand**

Tubular stand for bolt fixing or concrete fixing. Available in variable lengths. The stand is for freestanding applications only.

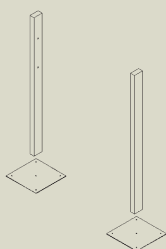

#### **PFE Frame**

Rectangular aluminium frame for bolt fixing or fixing into concrete. Base plate for bolt fixing available as an extra. The frame is for freestanding applications only.

# colours, finishes and engraving

Below is a list of our standard colours. Any RAL colours are available on request. This colour chart is for reference only. Samples of finishes and colours are available on request. Due to the limitations of the printing process total colour match must be checked against the official powder coating classic RAL colour deck.

## Finishes



▲ Examples of permanent engraving



The information in this catalogue is given in good faith. Every endeavour is made to ensure accuracy but we cannot accept responsibility for errors that may arise in the text. We reserve the right to modify patterns and withdraw or alter information without notice. Due to printing processes, the colours of the products may vary slightly to those of the actual items. E&OE. (Errors & Omissions Excepted)

# our first class service - six steps to order

## 1 INITIAL ENQUIRY



## 2 SEND US YOUR IDEAS / SKETCHES



## 3 RECEIVE OUR QUOTE & ILLUSTRATION



## 4 PRODUCTION

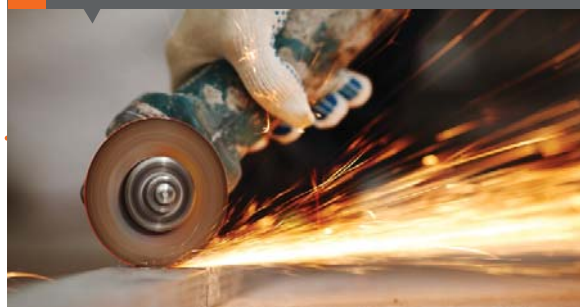

## 5 DELIVERY & INSTALLATION



## 6 ANOTHER SATISFIED CUSTOMER!







**DAD UK Ltd**

Units 12-15

Wotton Trading Estate

Ashford

Kent TN23 6LL

**T:** 01233 630406

**F:** 01233 630708

**E:** [info@dadgroup.co.uk](mailto:info@dadgroup.co.uk)

**W:** [www.dadgroup.co.uk](http://www.dadgroup.co.uk)